

KS CASSETTE STEAM STERILIZER  
USER'S MANUAL  
**STE-CAS-2/STE-CAS-5/STE-CAS-6**



**PLEASE READ THIS MANUAL CAREFULLY BEFORE OPERATION**

3, Hagavish st. Israel 58817 Tel: 972 3 5595252, Fax: 972 3 5594529 [mrc@mrclab.com](mailto:mrc@mrclab.com)

**MRC. 7.19**

---

1	Introduction and important information	3
2	Product overview	4
3	Symbols	4
4	Specifications	5
5	Installation	6
6	Sterilization cycles	7
7	Using a cassette	8
8	Language, time and printer setting	8
9	Loading a printer paper	9
10	Setting water quality limit and pressure	10
11	Default sterilization cycle setting	11
12	Resetting a sterilization cycle	12
13	Loading Instruments	13
14	Running a sterilization cycle	13
15	Sterilization cycle report	14
16	Maintenance	14
17	Spare part list	15
18	Trouble shooting	15

---

## 1. Instruction and important information

This compact sterilizer is suitable for the sterilization of all types of dental and medical instruments, which withstand the steam of high temperature.

This unit is not designed to sterilize cloth loads, liquid, powder and materials not compatible with steam. It may result in incomplete sterilization, and damage the unit.

Use the distilled water, pure water or ultra pure water with its conductivity less than 10 $\mu$ S/cm, any water other than the above mentioned may damage the steam generator and void the warranty.

The manufacturer shall not be liable for incidental and consequential damages and losses caused by any maintenance performed on the unit by a third party, which doesn't have the manufacturer's authorization.

This sterilizer is for indoor use only.

Please read this manual before operating the unit!

Contents of this manual are subject to change without notice!

## 2. Product overview

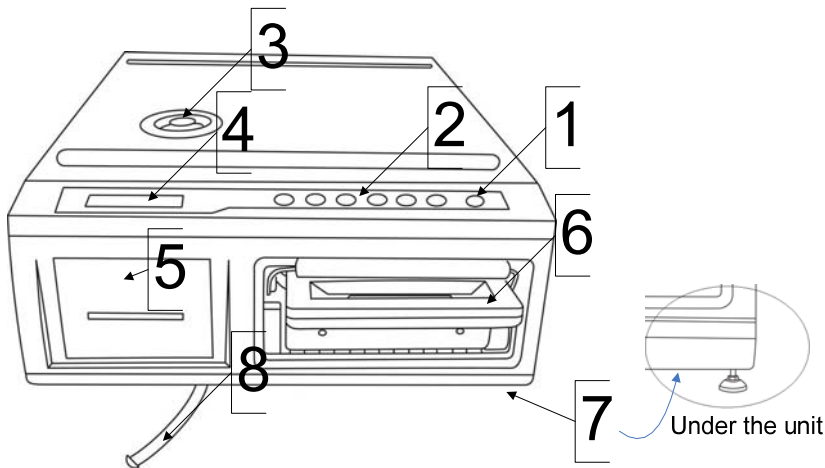

Front view

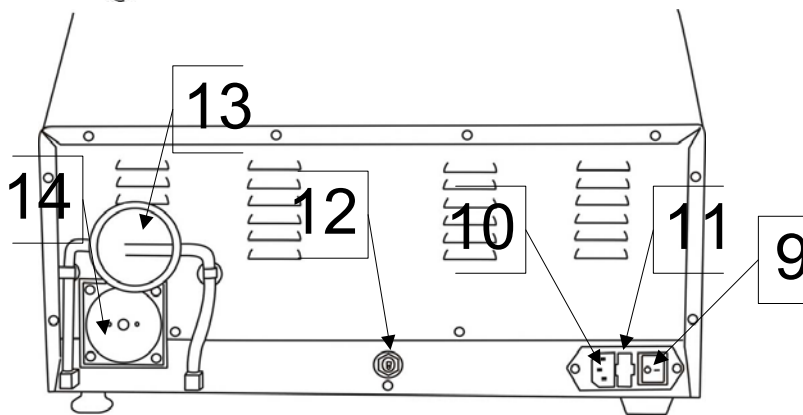

Back view

- |                        |                           |                             |
|------------------------|---------------------------|-----------------------------|
| 1. Level indicator     | 2. Keypad                 | 3. Reservoir cap            |
| 4. LCD                 | 5. Printer                | 6. Cassette                 |
| 7. Adjustable feet     | 8. Water drain tube       | 9. Power switch             |
| 10. Power cable socket | 11. Fuse                  | 12. Steam exhaust tube port |
| 13. Air pump           | 14. Biological air filter |                             |

## 3. Symbols and functions



UNWRAPPED CYCLE  
\* Setting function: +



AIR DRYING CYCLE



Potential hazard!



WRAPPED CYCLE  
\* Setting function: -



CONFIRM



Caution, hot surface!



RUBBER & PLASTICS CYCLE  
\* Setting function: scroll



STOP



Important information

\* While setting the parameters of the cassette autoclave, the key has this extra function.

## 4. Specifications

Type: STE-CAS-2 Cassette autoclave	
Dimensions (L*W*H, mm)	620*415*170
Cassette external size (L*W*H, mm)	390*196*40
Cassette internal size (L*W*H, mm)	280*180*38
Cassette volume (liter)	1.8
Reservoir volume (liter)	3.4
Maximum steam temperature(°C)	138
Electrical rating	220VAC±10%, 50Hz, 8A
Weight(kg)	27

Type: STE-CAS-5/6 Cassette autoclave	
Dimensions (L*W*H, mm)	580*460*190
Cassette external size (L*W*H, mm)	480*196*80
Cassette internal size (L*W*H, mm)	380*180*78
Cassette internal size (L*W*H, mm)	490*180*78 (STE-CAS-6)
Cassette volume (liter)	5.2
Reservoir volume (liter)	3.4
Maximum steam temperature(°C)	138
Electrical rating	220VAC±10%, 50Hz, 8A
Weight(kg)	37

Printer	
Type	Thermal
Paper roll	Width 57 mm, roll diameter 48 mm, approx. 180 cycles per roll
Print speed(mm/s)	5

## 5. Installation



Before the installation and commissioning, please review the following factors, which may affect the performance of the sterilizer.

- a) Avoid direct sunlight or close to a heat surface. The recommended ambient temperatures are 5°C to 40°C with the relative humidity of 10% to 80%.
- b) Leave a minimum clearance of 30cm on the top, 10cm at the sides and the back, enough space in the front for operation.
- c) To be operated in a clean environment on a flat, level and water resistant surface.
- d) Recommend that the unit be kept away from potential electromagnetic sources.
- e) Use properly grounded and fused power sources, the same voltage rating as indicated on the label at the back of the unit.
- f) Adjust the feet to move the bubble inside of the level indicator, which should be balanced in the right quadrant as indicated. (Refer to figure 5.f)
- g) Connect the waste barrel to the unit to collect the steam and the condensed water from the cassette. (Refer to figure 5.g)
- h) Remove the reservoir cap to pour the water into the reservoir, maximum 3.4 liters. (Refer to figure 5.h)
- i) Use the distilled water, pure water or ultra pure water with its conductivity less than 10 $\mu$ S/cm.
- j) To empty the reservoir, remove the plug at the end of the drain tube.



Figure 5.f

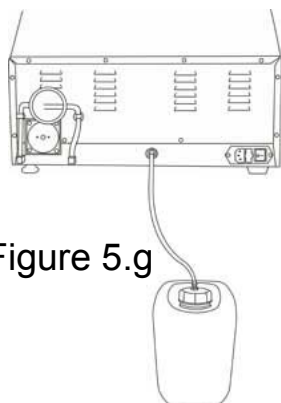

Figure 5.g



Figure 5.h

## 6. Sterilization cycles

### UNWRAPPED CYCLE

Used for the sterilization of solid metal instruments, such as pliers and forceps. Dental hand-pieces can be sterilized in this cycle. Total load up to 1 kg.

Put the unwrapped instruments, which neither touch each other nor touch the cassette surface, on the instrument rack.

### WRAPPED CYCLE

Used for the sterilization of solid and hollow metal instruments sealed in paper or plastic bags.

Ensure that all wrapped instrument loads into the cassette are dry before sterilizing.

Recommend to use the plastic/paper bags for wrapped instruments, the use of cloth wraps is not recommended.

To allow steam penetration to all instrument surfaces, pack instruments in the bags loosely.

### RUBBER AND PLASTICS CYCLE

Used for the sterilization of unwrapped instruments constructed of metal and rubber or plastics.

Materials can be sterilized in this unit, such as Nylon, PTFE, polycarbonate, polypropylene, acetal, polysulfone, silicone, rubber, polyester, etc. Materials can not be sterilized in this unit, such as Polyethylene, ABS, styrene, PVC, Acrylic, latex, neoprene, etc.

### AIR DRY CYCLE

This is not a sterilization cycle! It runs automatically after each sterilization cycle, the working time can be adjusted.

It can not be re-started if the cassette has been removed and re-inserted.

To stop the drying, just press the EXIT button at any time.



If you are unsure of your instrument's material or construction, please do not load into the cassette until you have confirmed with the instrument manufacturer.

## 7. Using a cassette



Caution, hot surface! While removing and opening the cassette after a sterilization cycle, please keep off the potential steam inside the cassette.

### TYPE:SK-2000

Remove or insert



### TYPE:SK-5000



Push downward on the latch to OPEN

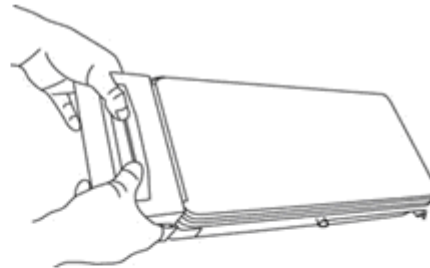
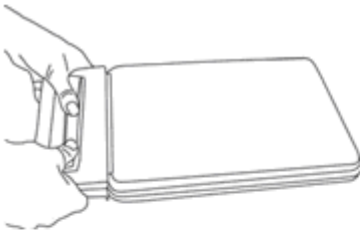

Open or close

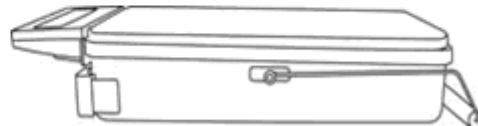
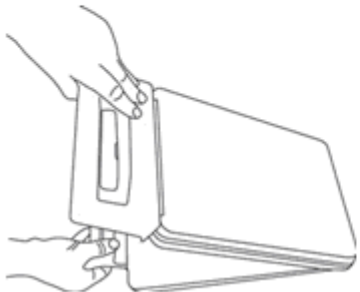

When not in use, don't fully insert the cassette into the unit, leave a gap about 2 or 3 cm. Otherwise the unit is ready for running, the solenoid valve will be always powered ON.

A sudden and forcible pushing of the cassette into the unit may damage the components inside.



## 8. Language, date/time and printer setting

1a Press this button, don't release it and switch on the power until LCD displays the following information:

2.1 **Language** Date/Time  
Printer

"2009" changed to  
"2010"

2.1a Confirm the selection.

3.3a Scroll down to select the desired.

2.2 **English**  
...

3.3b + or - Press keys to add or reduce the values.

2.2a Scroll down to select the desired.

3.3 2010 - 03 - 21  
09 : 12 : 39

2.2b Confirm the selection.

3a Scroll down to the next setting.

4a Scroll down to the next setting.

3b Confirm the selection.

4b Confirm the selection.

3.1 Language **Date / Time**  
Printer

4.1 Language Date / Time  
**Printer**

3.1a Confirm the selection.

4.1a Confirm the selection.

3.2 2009 - 03 - 21  
09 : 12 : 16

4.2 **Printer ON**  
Printer OFF

3.2a + or - Press keys to add or reduce the values.

4.2a Scroll down to select the desired.

3.3 2010 - 03 - 21  
09 : 12 : 16

4.2b Confirm the selection.

5a Return to main menu

## 9. Loading a printer paper

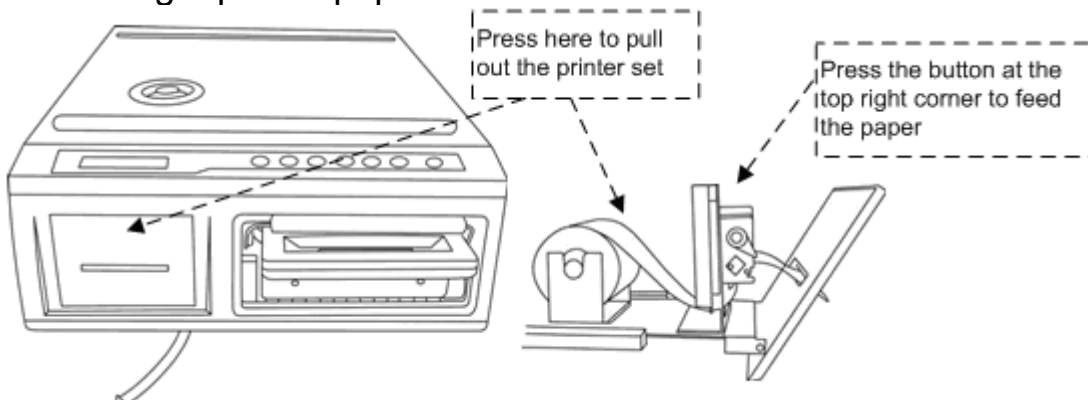

## 10. Setting water quality limit and pressure

Recommend to use the distilled water, pure water or ultra pure water with its conductivity less than 10 $\mu$ S/cm. Even if the above mentioned water stays in the reservoir for more than 2 or 3 days, its conductivity will become larger and the quality becomes worse.

How to reset?

Switch on the power, don't insert the cassette, LCD displays "INSERT CASSETTE" as follow:

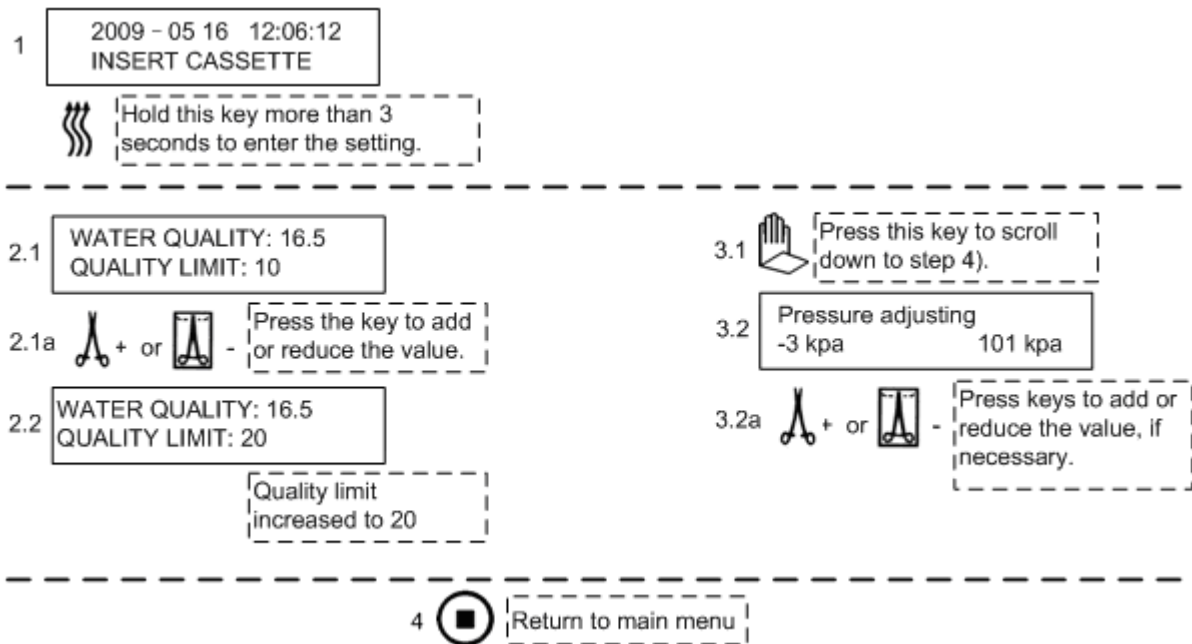

2.1) **WATER QUALITY: 16.5**, which mean the detected quality value of the water in the reservoir. This value is a relevant conductivity value according the manufacturer's standard.

**WATER LIMIT: 10**, which are set by user, who does not allow to use the water below this quality.

Usually WATER QUALITY is always lower than QUALITY LIMIT, otherwise LCD shows an error message 3, "water quality not acceptable". Under this circumstance, the user should change the water or enlarger the limit to continue running the unit.

The water limit can be set from 0 to 50, not recommend to set larger than 15, unless under emergency situation.

2.2) To continue running it without changing the water inside the reservoir, you can just adjust QUALITY LIMIT larger than WATER QUALITY.

3.2) This is only for monitoring the pressure inside the cassette, if the first value is among -5 kpa to 5 kpa, don't need to do any adjustment. If larger than 10kpa, please contact the manufacturer.

## 11. Default sterilization cycle setting

Cycle name	Sterilization		Air purge**	Air drying***
	Temperature	Duration		
	°C	minute	time	minute
Unwrapped	135	4	1	5
Wrapped	135	10	3	5
Rubber & plastics	121	30	3	5
value adjustable*	115~135	4~99	1~6	0~99

The above values are factory setting.

\* To meet different sterilization requirements, users are allowed to adjust the sterilization temperature, the sterilization time, the air drying time and the air purge times. The values can be adjusted among the minimum and the maximum.

\*\* More air purges will allow deeper steam penetration to all instrument surfaces. Recommend to use at least 3 purges to sterilize the instruments, such as dental hand-pieces.

\*\*\* 0 minute means that the air drying cycle will not start after a sterilization cycle complete.

## 12. Resetting a sterilization cycle

The sterilizing temperature, time, air drying and purges may vary from different instruments and loads to be sterilized. In this case, it's necessary to re-set the above values.

Take UNWRAPPED cycle as an example:

- 1) Default: 135°C, 4 minutes, 5 minutes of air drying, 1 air purge
- 2) Re-set : 134°C, 6 minutes, 3 minutes of air drying, 3 air purges

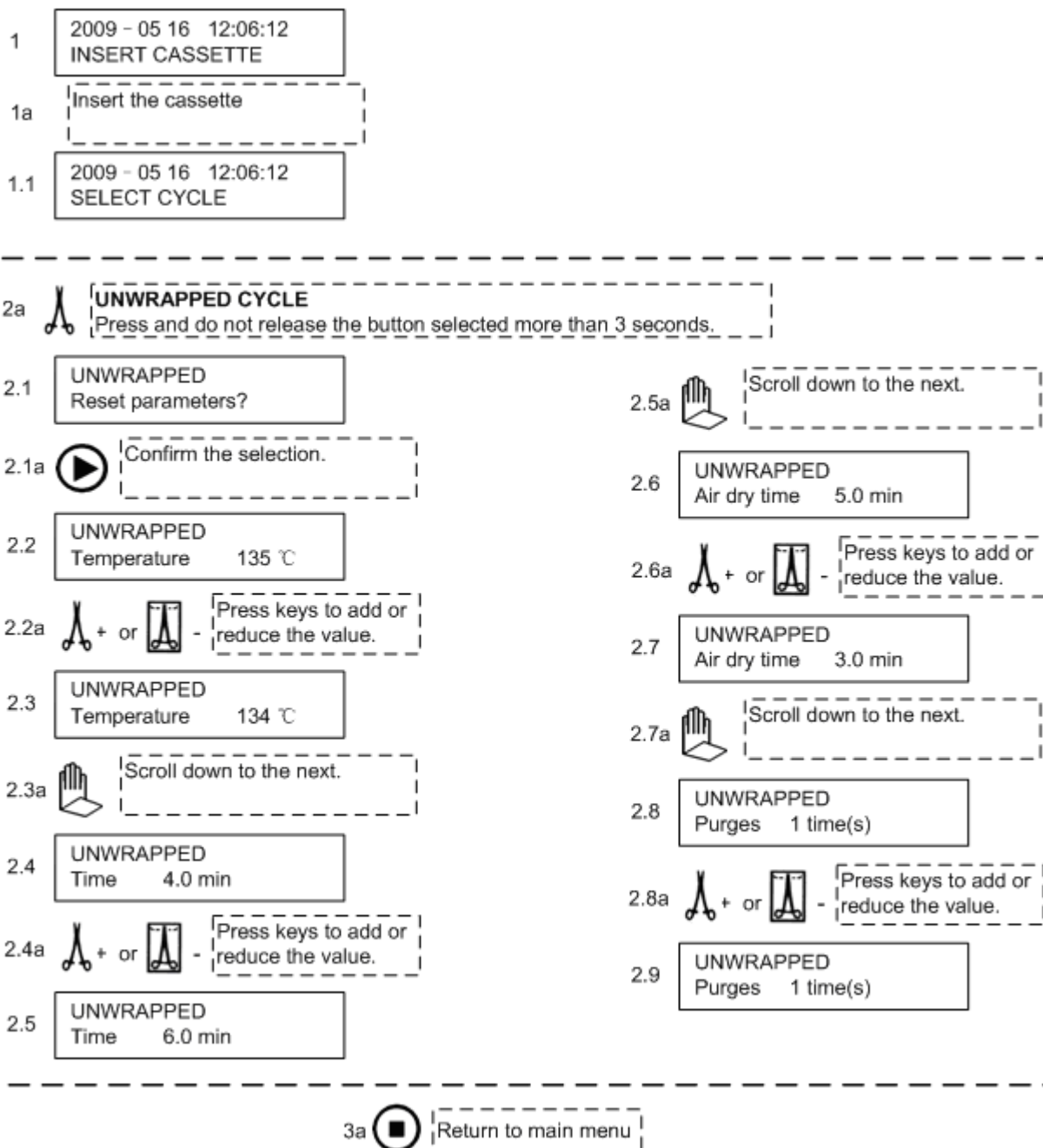

Please refer to the above steps to re-set WRAPPED, RUBBER & PLASTICS and AIR DRYING cycles in turn, if necessary.

### 13. Loading Instruments

Clean and raise all instruments before loading them into the cassette. Disinfectant residues and solid debris may affect the sterilization.

Instruments unwrapped, wrapped, rubber and plastics must not be stacked or piled on the instrument rack in the cassette, not be touched each other and not touch the cassette surface, as this is to ensure the steam can reach all instrument surfaces, otherwise it may lead to an incomplete sterilization.

Best to allow all instruments unwrapped or wrapped to dry completely before loading into the cassette, as this is to enable effective sterilization.

### 14. Running a sterilization cycle

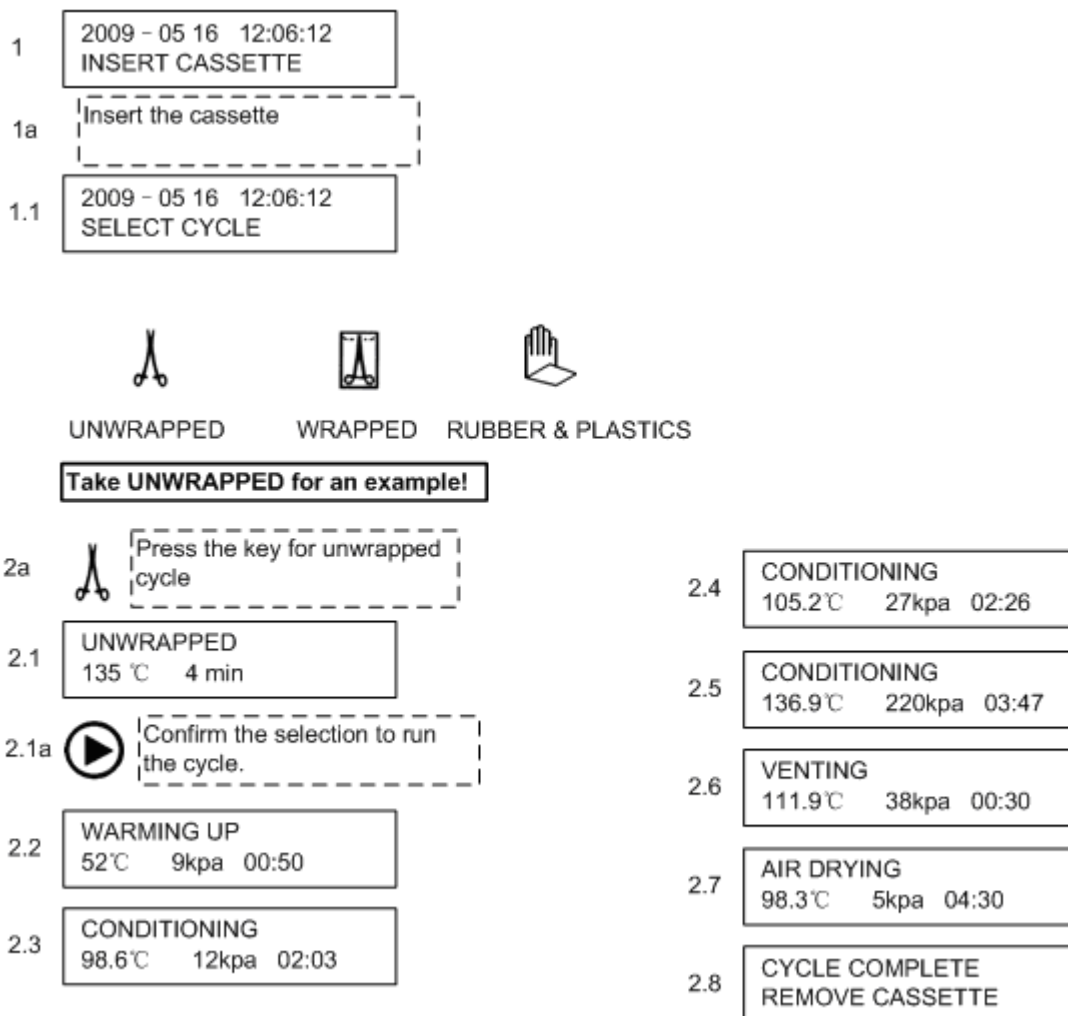

When pull out and open the cassette, please notice the high temperature inside the cassette. It shows on the LCD as step 2.7.



Caution, hot surface! While removing and opening the cassette after a sterilization cycle, please keep off the potential steam inside the cassette.

## 15. Sterilization cycle report

If the printer is set “ON” (refer to chapter 8, setting printer), there is a report as follow or a failure report with “low temperature”, “sensor errors” or “aborted”.

Start time:	2008-01-01 12: 00: 01		
Cycle:	UNWRAPPED		
Temperature:	135 °C		
Sterilization:	0240 sec		
Drying:	1800 sec	Purges:	0001 times
	Time	°C	kPa
Warming up	12: 00: 10	024.3	001
Conditioning	12: 01: 05	095.1	016
Pressurizing	12: 01: 43	104.0	027
	12: 02: 43	123.5	123
	12: 03: 43	132.2	184
Sterilizing	12: 04: 50	135.3	218
	12: 05: 20	136.9	223
	12: 05: 50	135.4	216
	12: 06: 20	135.2	214
	12: 06: 50	135.7	218
	12: 07: 20	135.4	216
	12: 07: 50	135.2	215
	12: 08: 20	135.5	219
	12: 08: 50	135.1	213
Sterilizing cycle complete			
Venting	12: 08: 50	135.1	213
Air Drying	12: 09: 53	103.5	009
End	12: 39: 53	035.8	007

## 16. Maintenance

### Daily:

Wash the interior and the exterior of the cassette with chorine free detergent, then rinse thoroughly with the distilled water.

### Weekly:

Check the biological air filter. If dirty, replace it. If wet, refer to Errors and error remedy.

Replace the biological air filter every 6 months.

### Every 6 months :

Check the cassette seal.

Or replace the seal every 6 months.

### An annual calibration of the unit:

It depends on the user’s demand.

## 17. Spare parts list

Item	Description	ID.	Remarks
1	Water pump	KS1802	
2	Air pump	KS1803	
3	Solenoid valve	KS1801	
4	Temperature sensor	K10317	
5	Pressure sensor	KS1807	
6	Steam generator	KS1809	
7	Cassette(STE-CAS-2)	KS1813	
8	Press button	K10058	
9	Printer	K10064	
10	Power supply board	K10231	
11	Control board	K10230	
12	Cassette (STE-CAS-5)	KS5205	
13	Cassette(STE-CAS-6)	KS6001	
14	Air filter	K10110	
15	Cassette seal(STE-CAS-2)	K10091	
16	Cassette seal(STE-CAS-5/6)	K50006	
17	Printer paper	K10307	

## 18. Trouble shooting

Error messages	Possible causes	Remedy
1 CASSETTE REMOVED IN RUNNING	Cassette removed in running	
	Cassette position switch failure	Replace the switch.
2 REFILL RESERVOIR	The level of the water in the reservoir is too low.	Refill the reservoir.
	Water quality not acceptable	Refer to "Water quality limit setting"
	Conductivity sensor failure	Replace the sensor.
3 WATER QUALITY NOT ACCEPTABLE	Low water quality	Use qualified water.
		Adjust the water quality limit value, refer to "Water quality limit setting"
4 LOW TEMPERATURE, CYCLE ABORTED	Solenoid valve keeps open during pressurizing state.	Replace the valve.
	Temperature sensor failure	Replace the sensor.
	Possible other causes	Contact the manufacturer.
5 CYCLEABORTED IN RUNNING	Exit key pressed in running.	
	Key function failure	Replace the keypad.
6 CHECK STEAM BOILER SENSOR 7 CASSETTE TEMPERATURE SENSOR 8 CHECK PRESSURE SENSOR	Cable or connectors failure	Check with Ohmmeter. Replace them, if necessary.
	Temperature or pressure sensor failure	Replace the sensor.
9 WARMING UP TIME TOO LONG 10 CONDITINING TIME TOO LONG 11 PRESSURIZING TIME TOO LONG	Excessive steam leakage from the cassette	Replace the cassette seal or the cassette.
	Excessive steam leakage from other positions	Replace the related parts.
	Water pump failure	Replace the pump.
	Solenoid valve failure	Replace the valve.
12 STEAM BOILER FAILURE	Possible other causes	Contact the manufacturer
	Cable failure	Check the cable
	Temperature fuse broken	Replace the fuse or controller.
	Steam generator failure	Replace the steam generator.